



- Constant monitoring of battery circuit integrity
- Deep discharge protection
- Controls load and charge current independently
- Overload, short circuit & reverse polarity protect
- Automatic battery temperature compensation
- High efficiency switch mode design
- No transition switching between PSU & backup battery
- LED flash codes for precise state indication
- Two alarm relay outputs standard
- Suitable for use with all types of lead acid batteries (batteries external to power supply)
- Optional periodic battery testing.

**SPECIFICATIONS** All specifications are typical at nominal input, full load and at 20°C unless otherwise stated.

## SMART DC UPS: SYSTEM DESCRIPTION AND FEATURES

A Smart DC UPS system consists of the DC power supply, together with backup battery which is usually installed as the last line of defence in the event of loss of mains power.

The system incorporates common sense features providing a vastly improved solution over the traditional methods of float charger plus battery. The battery is accurately charge current limited and you cannot overload the charger or over-heat the battery.

The Smart DC UPS is the ideal solution for: 1-Critical systems from 250W to 750+ W , 2- Applications having standing load with back up standby battery installed , 3- Systems which require no transition from mains to battery backup 4- Emergency lighting systems. 4-Scada systems with automatic battery monitoring. And testing.

**Our Smart DC UPS systems** ensure maximum uptime of the system, and life of the battery, by providing:

- ◆ Independent battery charge current limit
- ◆ Monitoring of the battery status and availability at all times
- ◆ Independently limiting the charge current to the battery, thus ensuring load receives priority (most units can have load : charge ratio altered to suit battery size).
- ◆ Protecting against overload, short circuit and reverse polarity connection, incorporating ELCB (electronic circuit breaker , series III only)
- ◆ Deep discharge protection by disconnecting at low battery voltage.
- ◆ Temperature compensation of battery charge voltage - essential for battery health where ambient temperatures fluctuate.
- ◆ Alarm contacts to enable interfacing with monitoring equipment such as PLCs, SCADA, security, telemetry and myriad others - standard alarms are Power OK and Battery System OK.
- ◆ Optionally, performing regular battery condition testing at a predetermined interval and providing an alarm in the event the battery is suspect.

All of the features can be customized to a particular application, additionally we offer a range of packaging options to provide utmost flexibility:

- All of our standard enclosures enable installation in any normal location without safety concerns.
- Rack mounting to standard 19" enclosures
- Wall mounting with battery accommodation to house complete system including batteries

## ELECTRICAL

<b>Input</b>	180V-264VAC 45-65Hz or 200 - 375V DC (standard) , 88V-132VAC 45-65Hz or 110-180VDC (Upon Request )
<b>Fusing / Protection</b>	Internal AC input fuse, output battery fuse
<b>Isolation</b>	3.5KVAC 1 min. input / output, 1KV DC input / earth
<b>Efficiency</b>	≥ 85%
<b>Inrush current</b>	Soft start circuit
<b>Output Power</b>	250W, 500W, 750W continuous (0 - 50°C)
<b>Output Voltages</b>	13.8V, 27.6V, 41.4V, 55.2V Other voltages by request.
<b>Voltage adj. range</b>	85 - 105% of Vout
<b>Temp. Compensation</b>	Temperature sensor on 1.7m lead with adhesive pad: -4mV / °C / cell ±10%
<b>Current Limit</b>	Straight line profile
<b>Line Regulation</b>	<0.2% over AC input range
<b>Load Regulation</b>	<0.4% open circuit to 100% load
<b>Noise</b>	<1%
<b>Drift</b>	0.03% / °C
<b>Hold-up time</b>	15 - 20 ms (nom. - max. Vin) without battery
<b>Thermal Protection</b>	Automatic current reduction if >50°C. Self-resetting
<b>Overvoltage Protection</b>	Over-voltage protection on output at ~ 130% of nominal output voltage
<b>Battery Overcurrent Protection</b>	Electronic circuit breaker (ELCB) allows max. battery current of 1.5x I <sub>PSU</sub> continuous and trips when I <sub>load</sub> > 6 x I <sub>PSU</sub>
<b>EMI</b>	to CISPR 22 / EN55022 class A
<b>Safety</b>	to IEC950 / EN60950 / AS/NZS3260

## SMART DC UPS FEATURES

<b>Battery Charge Current Limit</b>	See Model Table for default settings. Charge current may be set to a max. of I <sub>PSU</sub> - I <sub>LA</sub> where I <sub>LA</sub> is actual load current
<b>Reverse Polarity</b>	Battery reverse connection will open internal fuse (and produce alarm)
<b>Battery Monitoring</b>	Detects for presence of battery after 1 minute on start up, then every 60 minutes when charge current < 200mA
<b>ELCB</b>	Electronic Circuit Breaker operates under the following conditions: - <b>battery discharged</b> ELVD (electronic low voltage disconnect) activates when battery voltage drops to 1.67V/cell (adjustable) - auto reset - <b>overload</b> Allows ~150% load from battery without acting, - <b>short circuit</b> Operates within 300ms for total load > 600% Acts within 2ms, backed up by fuse
<b>Indication LEDs</b>	Battery System OK, Power OK, Standby
<b>Alarms</b>	<ul style="list-style-type: none"> <li>Power OK (Mains/PSU fail, standby mode)</li> <li>Battery System OK - alarms when battery voltage low (on mains fail) , battery missing, battery circuit wiring faulty, BCT fail</li> </ul>
<b>Relay contacts</b>	C - NO - NC full changeover rated 1A /50V DC, 32VAC
<b>Standby Mode</b>	Turns off DC output of PSU & allows load to run off battery
<b>LED Codes</b>	Refer to next page for full list of flash codes indicating operating or fault conditions
<b>ACCESSORIES SUPPLIED</b>	Mounting Feet together with screws AC power cord Standard 1.5m lead with IEC320 socket / local plug 'Phoenix combicon' DC connector for 'X' version (max. wire 4mm <sup>2</sup> ) Mating screw-terminal plug for alarm outputs (max. wire 2.5mm <sup>2</sup> ) Crimp lugs for stud terminal versions

## ENVIRONMENTAL AND PHYSICAL

<b>Operating temperature</b>	0 - 50 °C ambient at full load De-rate linearly >50 °C to 0 load @ 70 °C
<b>Storage temperature</b>	-10 to 85 °C ambient
<b>Humidity</b>	0 - 95% relative humidity non-condensing
<b>Cooling -SR250</b>	Natural Convection except for 12V model which is Fan forced cooled
<b>Cooling -SR500 SR750</b>	Fan Forced using magnetic levitation fan
<b>AC Input connector</b>	IEC320 inlet socket (similar to PCs etc.)
<b>DC Output Connections</b>	M8 brass stud: or 'Phoenix combicon' plug-in style socket & mating screw terminal block: (max. wire 4mm <sup>2</sup> / way)
<b>Alarm Connections</b>	Plug in screw terminal block (max. 2.5mm <sup>2</sup> )
<b>Enclosure</b>	Powder coated aluminium
<b>Indicators</b>	<b>Green LEDs:</b> Power OK, Battery system OK <b>Red LED:</b> Standby

## ADDITIONAL OPTIONS

<b>19" Rack Mount</b>	2RU or 3RU 19" Rack Mount Enclosure
<b>Wall Mount Enclosure</b>	Enclosed Wall Mount cabinet with room for batteries, with MCBs and terminals.
<b>Temperature Probe</b>	To provide battery voltage temperature compensation
<b>METER</b>	Digital voltage and current meter available only the 19" rack mount enclosures and the wall mount enclosure
<b>Parallel redundancy</b>	Use external output diode: Diode can be fitted when ordering 19" rack mount option
<b>Battery Condition Test (BCT)</b>	Available as an option, please specify duration & frequency (factory default 1hour every 23 hours if enabled) Relay output provided for indication or to control external load.
<b>DC Input</b>	Available on request but has output fuse for short circuit protection , Voltage ranges: 110 -180VDC , 200-375VDC

## MODEL TYPES

MODELS	DC Output			
	Output Voltage (Load/Charger)	Max. Recomm.* Load Current (I <sub>LOAD</sub> )	Charge Current Limit (minimum)	PSU Rated Current (I <sub>PSU</sub> )
SR750U12	13.8V	42.0A	12.0A	54.0A
SR750U24	27.6V	19.0A	8.0A	27.0A
SR750U36	41.4V	12.0A	6.0A	18.0A
SR750U48	55.2V	8.5A	5.0A	13.5A
SR500U12	13.8V	27.0A	9.0A	36.0A
SR500U24	27.6V	12.0A	6.0A	18.0A
SR500U36	41.4V	7.0A	5.0A	12.0A
SR500U48	55.2V	5.0A	4.0A	9.0A
SR250U12	13.8V	12.0A	6.0A	18.0A
SR250U24	27.6V	5.0A	4.0A	9.0A
SR250U36	41.4V	3.0A	3.0A	6.0A
SR250U48	55.2V	2.0A	2.5A	4.5A

\* to allow for adequate charging current as load take precedent over charging of battery , The charge current limit can be increased depending on the application.

## MODEL PART NUMBER CODES

### SRPPPFVVCE-O-XXXX

**SR:** SERIES NAME

**PPP:** Output Power Level in watts: 250W , 500W , 750W

**F:** Function:

- U = Smart DC UPS System
- P = Standard power supply for float Battery charger
- B = Automatic Battery Charger with boost and float functions

**VVV:** DC Output voltage: 12V , 24V , 36V , 48V

**C:** Output Connector type: X = Phoenix plug in connector S = Stud terminals

**E:** Input voltage: L=230VAC , G=110VAC , J=110VDC

**D:** Case Style:







































**O:** OPTIONS:

- T = Temperature Compensation
- BCT = Battery Condition Testing
- AL = Alarms (AC Fail , Battery Low)
- MET = Digital Voltage and Current Meter ( Available on 19" rack mount and wall mount units )
- D = Parallel redundancy diode
- RM2 : 2U high Rack Mount enclosure to fit unit
- RM3 : 3U high Rack Mount enclosure to fit unit
- WM : Wall Mount enclosure to fit unit

**XXXX:** Special code for specific models

## ALARM AND INDICATOR CONDITIONS ON THE SRx-U

Please note that the last four conditions apply only if the battery condition test option is enabled.

Battery System OK LED	Power OK LED	Power Stand-by LED	Power OK Alarm	Battery System OK Alarm	Condition
			Normal	Normal	<b>System normal:</b> AC power is on, PSU output is OK, battery circuit is OK and battery voltage is > V Battery Low.
			Normal	Normal	<b>Battery Detection test in progress / imminent</b> (LED begins flashing 10 sec. prior to test of < 1 sec).
			Normal	Alarm	System AC power is on, PSU output is OK but either: 1. Internal battery fuse has opened (only if battery has been reverse polarity connected), <b>or</b> 2. Battery circuit open - battery missing, or fuse / circuit breaker / wiring fault.
			Alarm	Normal	Either: 1. AC power has failed, <b>or</b> 2. PSU has failed
			Alarm	Alarm	AC Power is off / DC has failed <b>and</b> battery has discharged to $\leq$ V Battery Low, unit will continue delivering battery current until low level initiates ELVD.
			Alarm	Alarm	AC Power is off / DC has failed <b>and</b> ELVD has activated and disconnected battery from load. Residual current drain on battery following ELVD <1 mA.
			Alarm	Normal	System is in STANDBY mode due to : 1. Operator pressed standby button, <b>or</b> 2. PSU has internal fault
			Alarm	Alarm	PSU is in standby <b>and</b> battery has discharged to $\leq$ Battery Low, unit will continue delivering battery current until next level initiates ELVD.
			Alarm	Alarm	PSU is in standby <b>and</b> ELVD has activated and disconnected battery from load. Residual current drain on battery following ELVD < 1mA
			Normal	Normal	Battery Condition Test is in progress: LEDs flash alternately
* 			Normal	Alarm	<b>Battery Condition Unserviceable:</b> failed to maintain terminal voltage during battery condition test
* 			Alarm	Alarm	<b>Battery Condition Unserviceable:</b> failed to maintain terminal voltage during battery condition test <b>and</b> System AC power or PSU has failed
* 			Alarm	Alarm	PSU is in standby mode <b>and</b> battery condition is determined as unserviceable: failed to maintain terminal voltage during battery condition test

LEGEND :



=Off



=Flashing



=On



=Flashing Slowly

## ELECTRONIC CIRCUIT BREAKER (ELCB) (CHARACTERISTICS CHART AS IMPLEMENTED IN THE SRx-U)

**System Current Limit (AC mains on)**

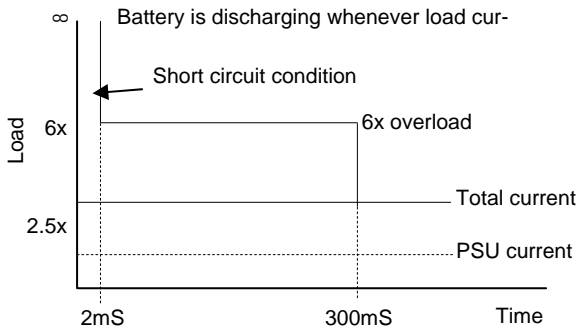

**System Current Limit (during AC fail)**

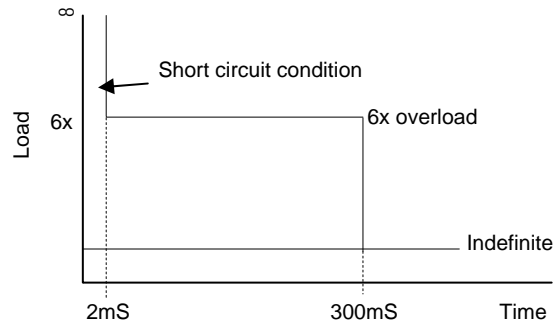

In both the above examples, the ELCB operates after 2mS under short circuit condition (battery connected). After 300mS of sustained overload, the ELCB operates. At all times the ELCB allows 50-60% system overload.

## SMART DC UPS: BLOCK DIAGRAM

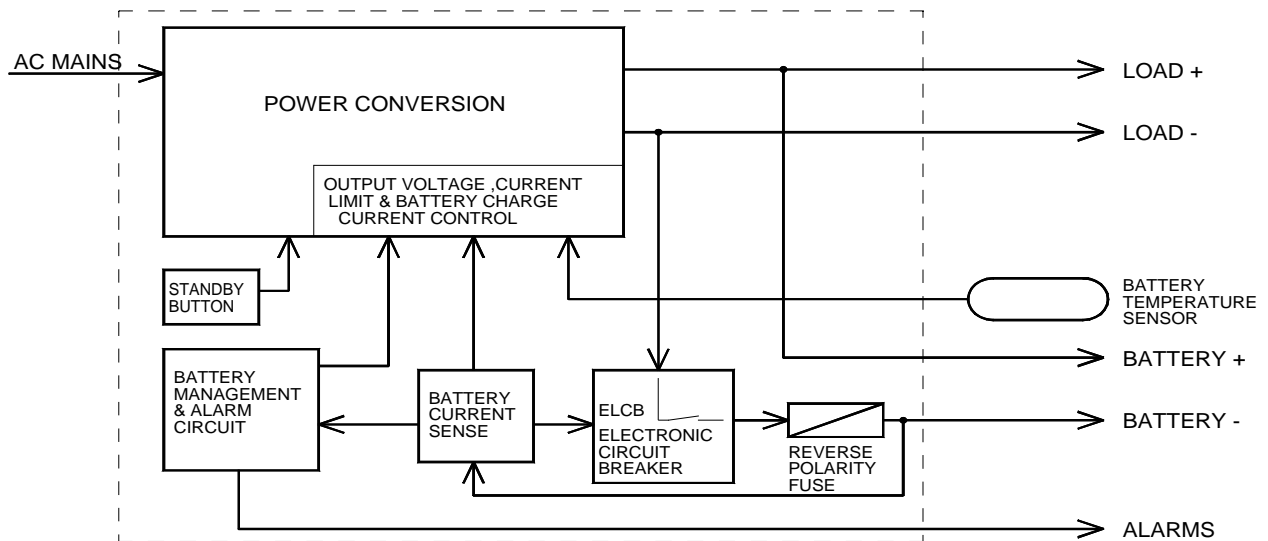

## ABOUT THE AUTOMATC BATTERY CONDITION TEST FEATURE

1. The **BCT** is an additional feature of the SRU series that supports the user in determining the condition of the back-up batteries. If implemented correctly it will provide an early warning for batteries showing age related problems. There are, however, limitations.
2. The **BCT** function ( if enabled) reduces the voltage of the power supply and allows the battery to power the load. During the **BCT** an additional relay changes state to indicate that the BCT is in progress. This relay may be used to add additional load current to provide a quicker and/or more meaningful test for the battery (see para. 7 below).
3. If the system detects that the battery terminal voltage has fallen below a set value the **BATT SYS OK** alarm will be activated and the Battery System alarm LED on the front panel will flash to indicate a fault condition. This battery 'ok / failure' threshold is usually set to 2.033V/cell (i.e. 48.8V for a 48V nominal system) but can be adjusted to suit the specific battery types and installation requirements. Once a battery failure condition is detected the power supply unit will immediately abort the test and revert to mains input power. The Battery System alarm LED will continue to flash and the BATT SYS OK alarm will stay latched (de-energized state) until either both the mains power input and the battery are disconnected briefly or the system passes the next BCT successfully.
4. The frequency and the duration of the **BCT** may be specified by the customer. The requested times will be set during the manufacturing process and cannot be altered later. See para. 8 below for a typical recommended setting.
5. The SR250/500/750 series also allow a manual start of a **BCT** by pushing the **BATT SYS OK** pushbutton on the front panel.
6. To prevent a BCT with partially discharged batteries a mains-fail can reset the internal BCT interval timer. The criteria for resetting the interval timer is that a mains-fail exceeds a specified time (i.e.5min) and that there are less then 2 days to the next scheduled BCT. The resetting of the interval timer delays the BCT by the interval time.
7. To improve the reliability of the BCT results, we recommend that sufficient load be applied to the battery during the test. If any additional loading is not applied directly to the battery connection but via the system then there is an upper limit of this loading. The SRU series DC system has a built-in electronic over-current protection in the battery circuit. This limit allows the battery to supply up to 1.5 times the rated current of the power supply unit continuously. If the battery current exceeds this value the electronic circuit breaker (ELCB) will open and disconnect the battery from the load.
8. A BCT performed at 2 monthly intervals with a battery loaded at  $C_{20}/4$  amps applied for 10minutes would provide some good indication. For a battery rated at a  $C_{20} = 100Ah$  the total load during the test should be 25A.
9. Care must be taken that the cabling to the battery is of adequate capacity to minimize voltage drops which are a cause of false alarms (battery reported as fail while still ok) when using the BCT function. I.e with the a 25A current and a 2m cable of  $6mm^2$  to the Battery a drop of  $\sim 300mV$  should be expected. It might be necessary to use separate wiring for additional battery loading.
10. In situations where the system load current fluctuates significantly the result of a BCT can become meaningless as the rate of discharge is unknown. Only additional (constant) loading to the battery during the BCT can improve this situation.
11. The SRU series is available with a 'T' option for temperature compensated battery charging. The battery 'ok / failure' threshold is not temperature compensated and the temperature dependency of the battery terminal voltage and capacity during a BCT needs to be taken into account.
12. The BCT should be used in conjunction with other maintenance checks in determining whether the battery system will operate in the event of a power failure. It should not be relied on as a definitive test as every battery has slightly different design and hence operating characteristics.

## APARALLEL REDUNDANCY CONNECTION DIAGRAMS

### Application Solution #1

2 x SR DC UPS units for increased power output.

This configuration should only be used when there is enough load to prevent one unit from switching off. In lightly loaded situations it is better to use two separate battery strings as shown in Application solution #2.

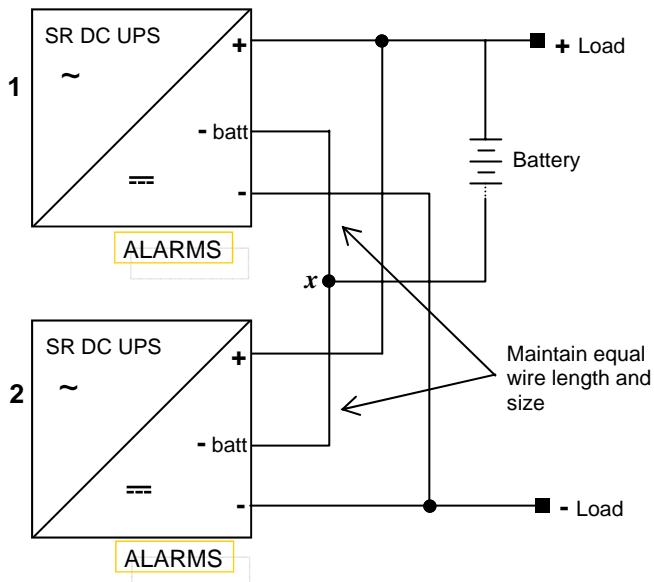

Notes: The wires which common the battery negative lead ('-batt' terminal to common point 'x') **must be** of the same type / gauge and equal in length.

### Application Solution #2

2 x SR DC UPS units and 2 x battery strings connected in parallel for N+1 redundancy (or increased power)

This solution provides an increased level of redundancy with redundancy of the battery in addition to the power supply. The diodes also aid current sharing and isolate the units from one another in the event of a short circuit appearing at the other output.

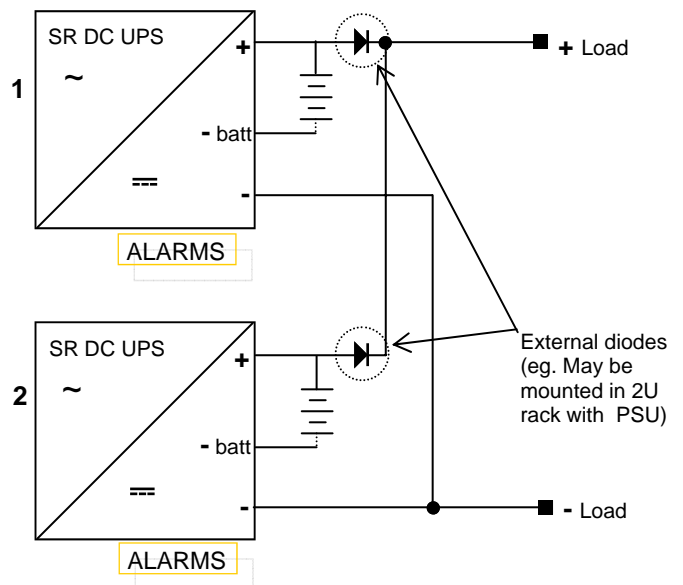

### Application Solution #3

Two or more SR xxx P (Standard PSU with alarms) units may be connected in parallel for N+1 redundancy using output diodes shown. For redundancy, normal practice is to install one additional unit than is necessary to power the load, thus the system is not compromised if one unit fails.

Note that the diodes are mounted external to PSU, except for the SR250P24,36,48 models.

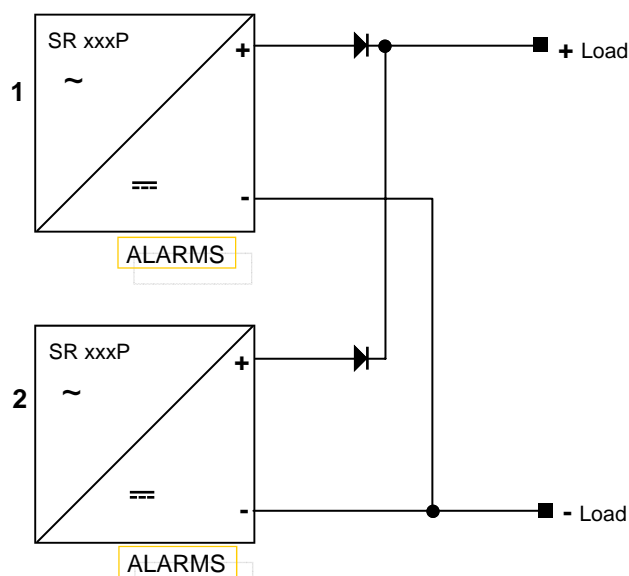

Two or more SR ... P ... units may be connected in parallel for increased power (without diodes). It is essential that the wiring from each unit to the load is kept identical for equal power sharing.

### Application Solution #4

Two SR xxx P (Standard PSU with alarms) units series connected for double output voltage

An example of this solution would be the requirement for 100V DC. The preferred solution is to use a specifically designed unit with the desired output, but if urgent or impractical, units can be connected as shown.

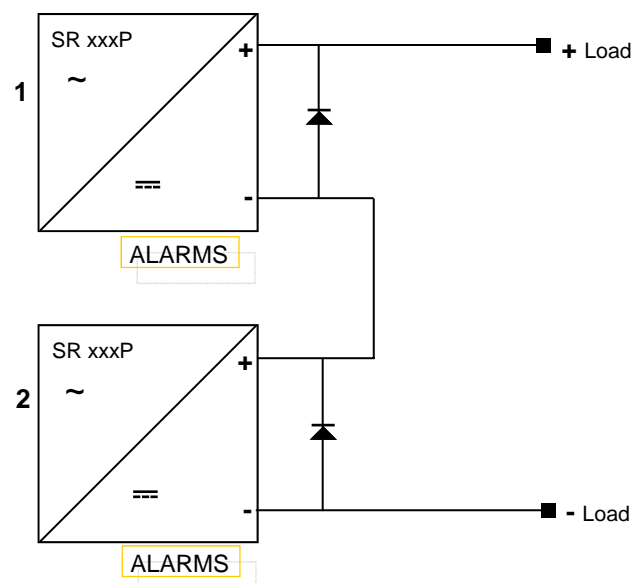

Diodes shown are essential.

## SMART DC UPS: SETTINGS AND VOLTAGE LEVELS

### General Specifications (at 20°C)

Parameter	V/cell	12V nom	24V nom	48V nom
Output (Float) Voltage	2.3V	13.8	27.6	55.2
Battery low alarm level (Batt Sys OK*) when no mains voltage present	1.84V	11	22	44
Battery disconnect level (ELVD)	1.66V	10	20	40

\* **Note:** Refer to LED flash codes on Page 5 to see which condition has activated the Batt Sys OK alarm

### Settings for Battery Detection

Automatic / manual detection	Automatic
Battery detection interval time	1 hour
Flash battery system LED for 10sec before battery detection test	No
Voltage level for battery detection alarm (Batt Sys OK*)	2.03V/cell (12.2,24.4, 48.8 for 12,24,48V nom)

**Settings for Battery Condition Test** ( if no values are entered below then this feature is disabled)

Microprocessor version: SFMCT- \_\_\_\_\_

Time between battery condition test	
Length of battery condition test	
Max. length of a mains fail without resetting to full test interval	4 hours
Battery condition test will be aborted if mains failure during test is greater than:	5 mins
Allow retest after battery condition bad	Yes (at next programmed time )
Voltage level for battery condition good / bad alarm - Batt System OK* (if voltage drops to this level during BCT then the test is aborted)	1.92V/cell (11.5, 23.0, 46.0 for 12,24,48V nom)
Battery condition test relay	Energised when test is in progress

### Battery Charge Current Limit

If this has been set to a higher value than the default setting then it will be noted on a separate label on the unit.

## SMART DC UPS: CONNECTIONS

Always connect the positive output of the charger to the positive terminal of the battery. It is essential to periodically check the electrolyte level of flooded cells as there is always some evaporation.

To minimize the volt drop at the output connections use all the terminals provided ie. Connect output wires in parallel.

### Functions of Front Panel Switches

**Standby:** Turns off DC output of PSU and allows load to run off battery (alarms at  $0.92 \times V$  nom and ELVD operates at  $0.88 \times V$  nom)

**Battery System OK:** If the battery condition test function is enabled, pushing this switch (for approx. 1 sec) will manually initiate a battery condition test (if mains power and battery are present)

### Initial Testing with no mains power present

To close ELCB (internal electronic circuit breaker) with no ac power present, briefly short together the **BAT -ve** and **LOAD -ve** terminals.

### Layout of alarm & battery condition test relay connections

Note that relays are **energised** when: Battery condition test is on, DC output is present, Battery System OK

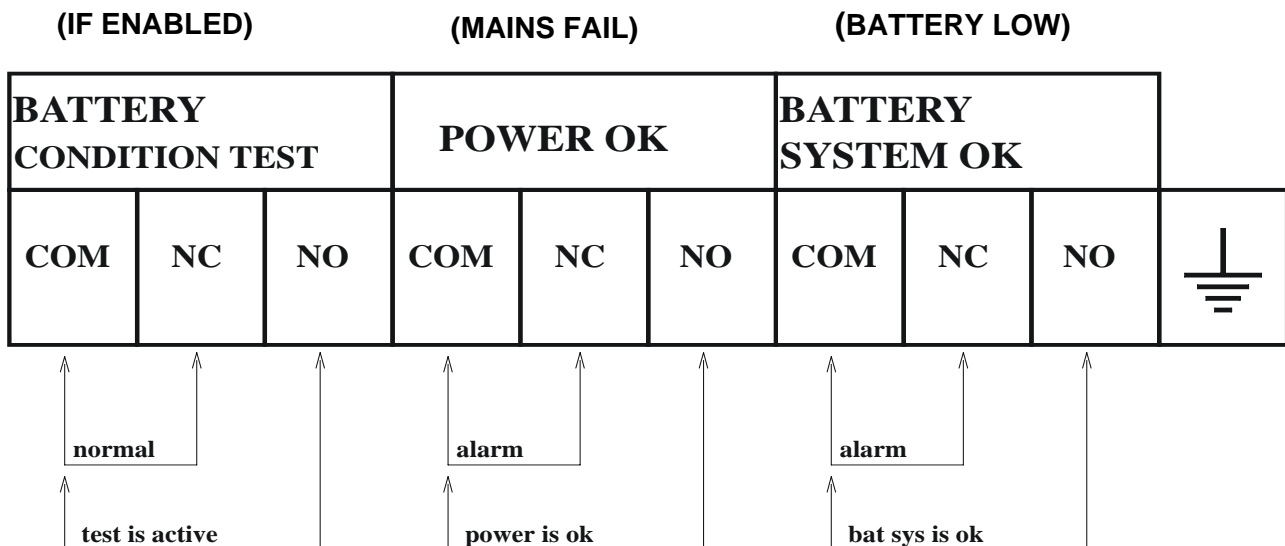

- NOTES:** 1. POWER OK alarm has 30 second delay before activation upon mains failure.  
2. POWER OK alarm is also activated when the PSU is in STANDBY mode.

### Fuse Ratings

The battery fuse and wiring should be rated at 1.5 x the rated PSU current.

The complete system is capable of delivering 2.5 x rated PSU current to the load and all load cabling should be rated for this current unless fused otherwise.

## MECHANICAL DRAWINGS Chassis Mount SR500 , SR750

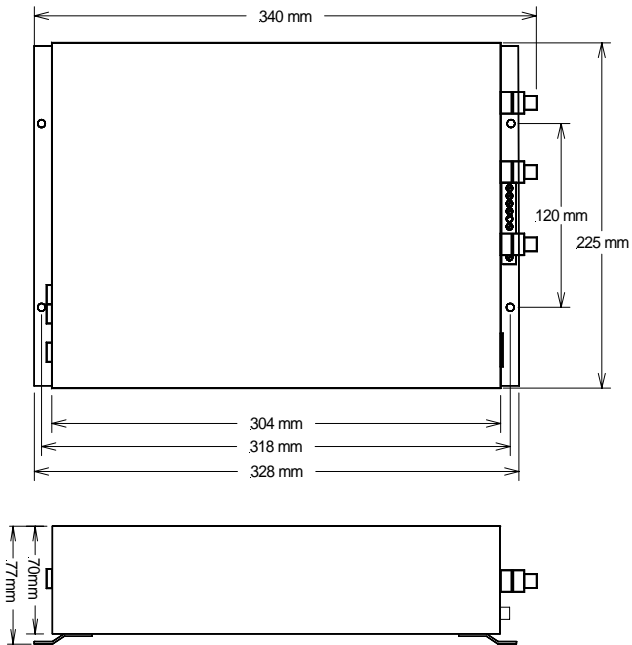

**Dims:** 328 x 225 x 70 mm  
**Weight:** 4.3 Kg



Picture of SR500U , chassis mount with temperature probe option , stud terminals for output

## MECHANICAL DRAWINGS Chassis Mount SR250

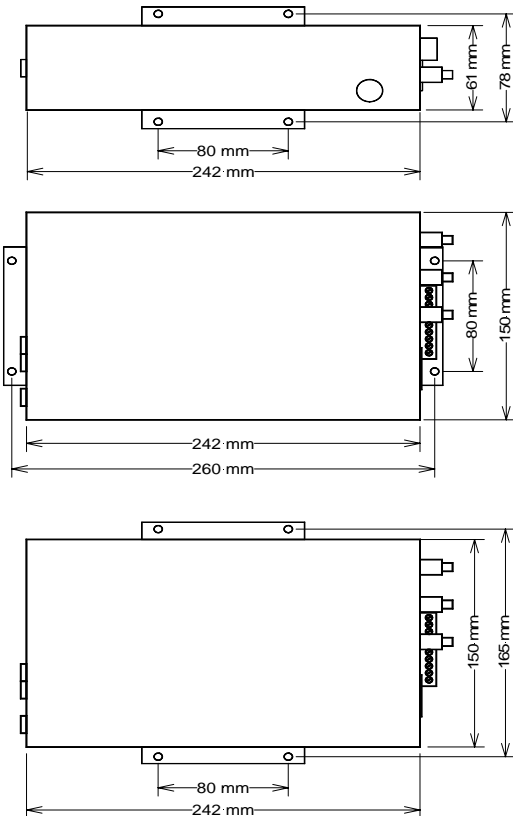

**Dims:** 260 x 150 x 61 mm

**Weight:** 1.7 Kg



## MECHANICAL DRAWINGS 19" Rack Mount 2RU , 3RU , SR250 SR500 SR750

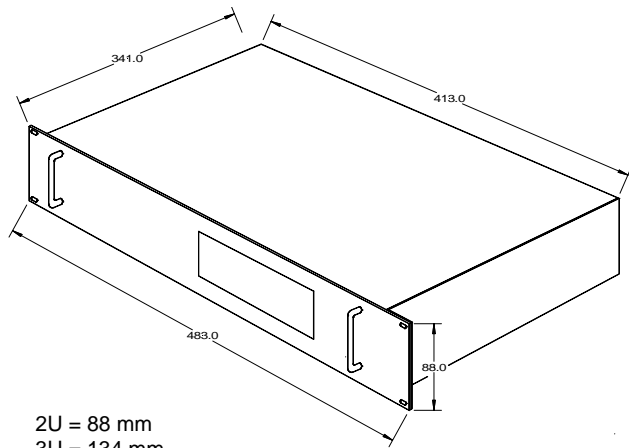

Picture of front view of a 19" 2RU rack mount unit with the digital voltage and current meter option



Picture of front view of a 19" 3RU rack mount unit with the digital voltage and current meter option